

TempTap™ Inlet Box with Breaker

UL 1008 Listed

3000A, up to 480VAC
Series: 3632

Features



- Solution for temporary remote connection of portable generator
- 3-Pole circuit breaker disconnect prevents energizing of cams unless door is closed
- Type 3R, heavy gauge galv. steel enclosure with wrinkle gray powdercoat RAL 7035 (stainless steel & additional colors optional)
- Color-coded cam style male inlets
- Door & deadfront panel for safe circuit breaker operation
- Safety-interlocked lower dead front for safe cable connection
- Hinged access plate secures cable entry compartment when not in use
- Dual side wireway extension for bottom conduit entry (can be omitted for other conduit entry/exit locations)

Drawing

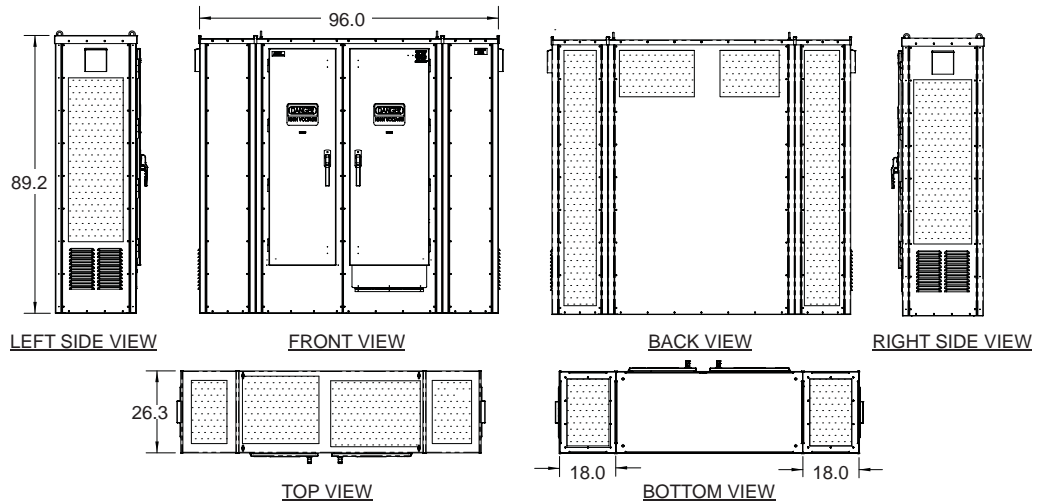

Available incoming conduit entry locations shown shaded

Approvals

- UL/cUL 1008 Listed assembly
- UL 1691 Listed receptacles
- UL 489 Listed / CSA certified molded case circuit breaker



Specifications

UL 1008 Listed

TempTap™ Inlet Box with Breaker
Series: 3632

Ordering Information

Example: IB32 - 3000C - 480 - 311 - S - C

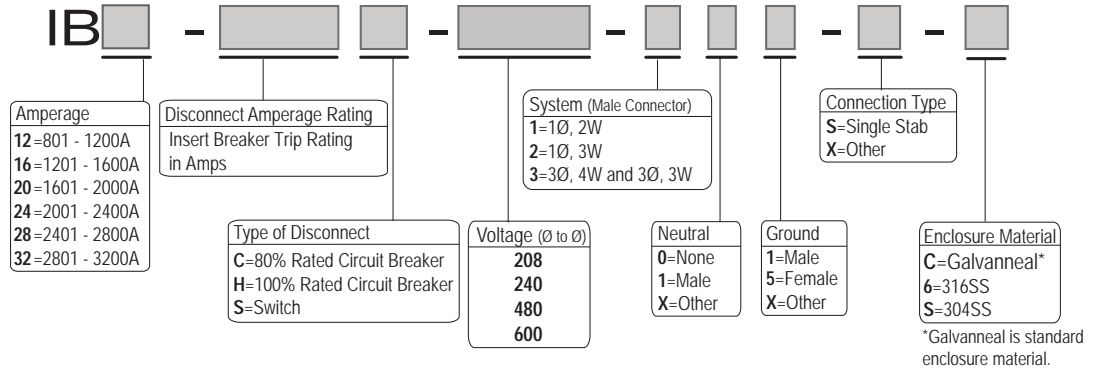

Contact factory for additional options

Ratings

Short circuit rating (breaker)	50kAIC @ 208VAC to 480VAC
Withstand rating (switch)	10kA @ 208VAC to 480VAC
Cam-style receptacles	(8) Sets of 400A, 600VAC for phase & neutral (3) 400A, 600VAC for ground
Terminals	Load terminals: (8) 300 - 800kcmil per phase/neutral Ground lug: (9) #2 - 600kcmil Other options available
Environmental	Type 3R, gasketed (Type 3RX with 304SS or 316SS option)

Packaging

Approximate Product weight	1,600 lbs.
Approximate Shipping weight	1,680 lbs.