

INTERLOCKED POWER MODULE

100AMP 480VAC

(100A 480VAC)

Catalog No: R100-480-90-65SSD-SP

Item No: 1700-97A

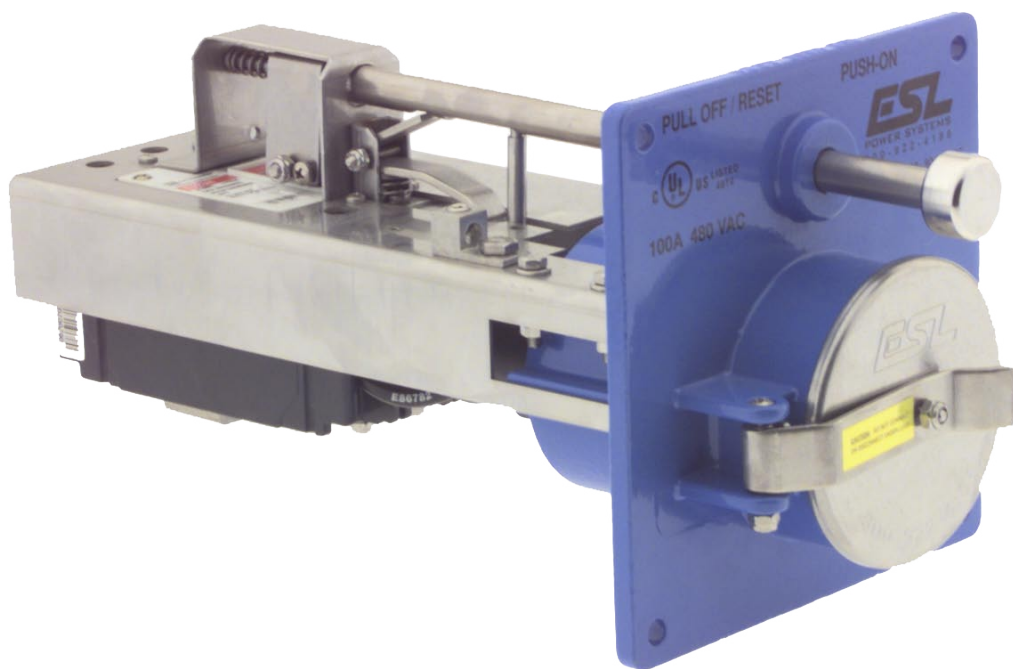

- Heavy Duty Stainless Steel Construction Resists Corrosion & Abuse
- Cast Stainless Steel Faceplate / Receptacle Housing
- UL Listed Circuit Breaker Protects Operator & Equipment
- Nickel Plated Brass Contacts & Unique Outlet Design Resists Corrosion & Arc Tracking

SPECIFICATIONS

Catalog No: R100-480-90-65SSD-SP

Item No: 1700-97A

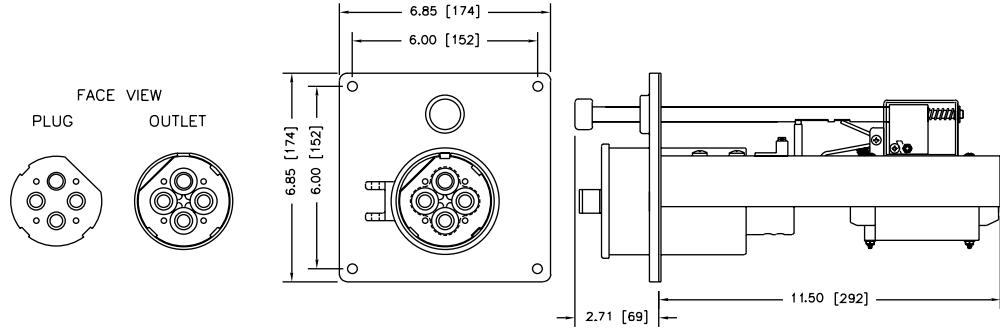

RATING:

- Receptacle - 100A 480VAC
- Circuit Breaker - 90A Trip / 65,000AIC @ 480VAC
- Environmental - Type 4X capable per NEMA 250, UL 50/508, CSA 22.2
- Terminals - (3) Phase & (1) Ground pressure type screw terminal
Phase: #6 - #2AWG (4-25mm²) Wire Range
Ground: #6 - #2 AWG (4-25mm²) Wire Range

MATERIALS:

- Stainless Steel - Frame, On/Off Rod, Interlock Mechanism, Contact Terminal Screws & Spring, Snap Cover, Receptacle Housing and all Fasteners
- Rynite - Contact Carrier
- Brass Nickel Plated - Contact Sleeves
- Neoprene (CR) - Gaskets, Cover Seals
- Buna-N (Nitrile/NBR) - O-Rings

APPROVALS:

UL Listed Module • UL 489 Listed / CSA Certified Molded Case Circuit Breaker

ACCESSORIES / PARTS

Description	Item No.	Description	Item No.
• Stainless Steel Snap Cover Assy	4036-03	• Circuit Breaker	4020-26
• Receptacle Insert & Contact Sleeve Assy	4010-36		

ESL Power Systems, Inc.

2800 Palisades Drive • Corona, CA 92880-9427
Tel: (951) 739-7020 • (800) 922-4188 • Fax: (951) 739-7048

www.eslpwr.com • e-mail: info@eslpwr.com

