

# Phase Rotation Test Plug

30A 240VAC  
 Catalog No: TP30-240  
 Item No: 1476-03

## Features



- Verifies correct phase sequence to ensure clockwise motor rotation
- Confirms presence of all 3 phases to prevent 'lost phase' failures
- Safe and easy to use:
  - Plug in and energize outlet
  - 3 indicator lights verify phases
  - "Pinwheel" reader verifies cw or ccw rotation
- Heavy duty watertight design for marine environment
- UL Listed pin and sleeve male plug

## Drawing

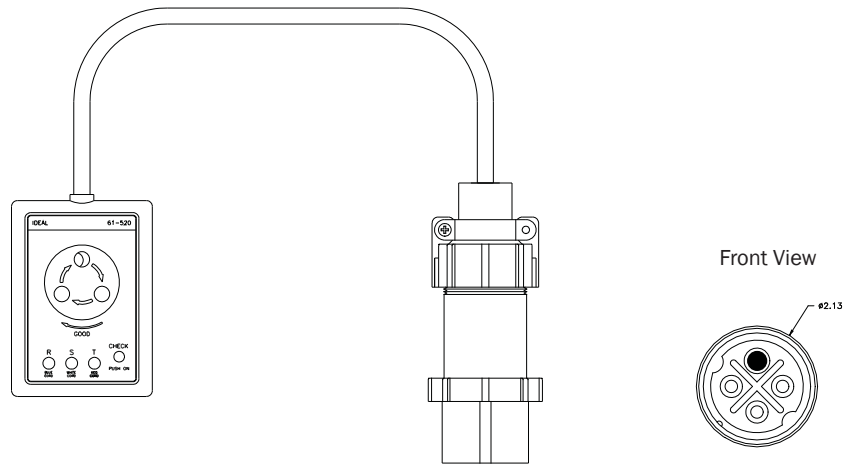

## Approvals

- UL Listed plug

## Specifications

Catalog No: TP30-240

Item No: 1476-03

### Ratings

Plug	UL/cUL, 30A 240VAC pin & sleeve 3 phase 3 wire + ground
Tester	CE, 100-660 VAC, 50-70 Hz, 7mA max (fused)
Cord	UL/CSA, 600VAC, 3 conductor

### Components

Plug	Polyamide housing
Tester	Non-metallic housing, neon indicator lights, solid state components, replaceable fuses
Cord	Oil abrasion and sunlight resistant

### Packaging

Approx. weight	2 lbs.
Approx. shipping weight	2.5 lbs.
Approx. shipping dimensions	12in x 9in x 5in